

GENERAL ASSEMBLY INSTRUCTIONS FOR 19MM LOG CABINS WITH GABLE ROOF AND ROOFING

This brochure has been compiled for all our 19 mm log cabins with gable roofs and roofing. The numbers and shapes may differ from those of the log cabin you have purchased.

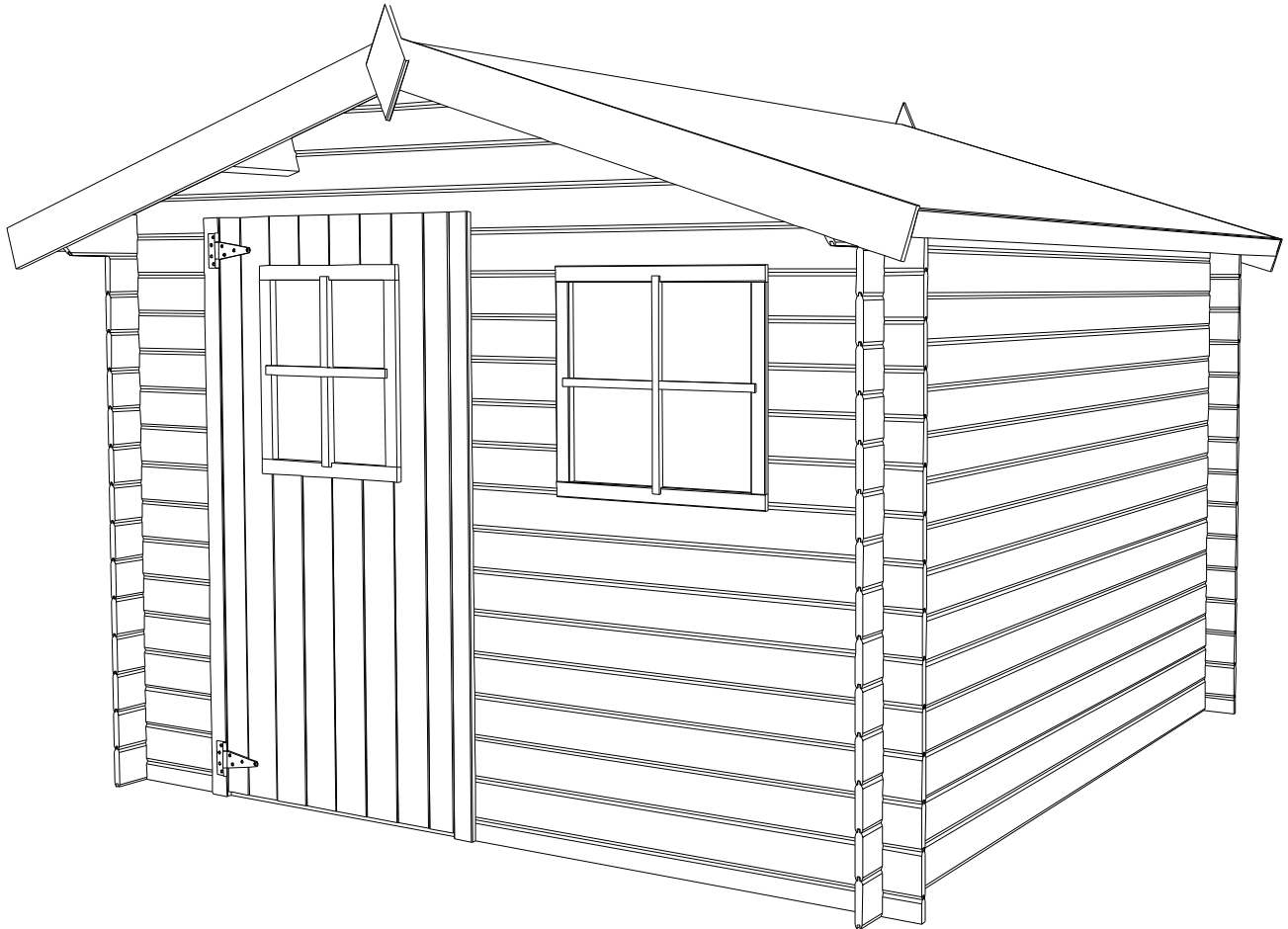

GARDENAS

TIMBER GARDEN CONSTRUCTIONS

GENERAL ASSEMBLY INSTRUCTIONS FOR LOG CABIN WITH GABLE ROOF 19MM (ROOFING)

Congratulations on the purchase of your log cabin.

If you read the assembly instructions carefully, you will enjoy your purchase for many years to come.

IMPORTANT!

Before you start assembly, we would like to give you some important information that deserves your attention.

A You have purchased a log cabin made from an untreated natural product. The wood still needs to be treated to ensure a long lifespan. It is best to seek advice from a specialist in the field when choosing your treatment product and maintaining your log cabin. Only use products that penetrate the wood and protect it against moisture, wind and weather, as well as insects and fungi. Do not use products that are so viscous that they prevent a good connection between the tongue and groove and the corner joints. You only have the opportunity to treat the tongue and groove **before** assembly. It is very important **to treat all parts on all sides**. This means you must also treat **the inside** of the log cabin.

B It is best to install a waterproof concrete base that is 10 cm larger than the outer dimensions of the log cabin. It is extremely important that your log cabin is level and remains so. Please note that if your structure does not remain stable after installation, gaps and deformations may occur in the log cabin. Ensure that ground moisture and other moisture cannot penetrate the wood by providing adequate ventilation of the log cabin and treating **the inside of** the log cabin against moisture. The bottom logs of your log cabin deserve extra attention, as they will be most exposed to water. Therefore, treat them with extra care. Seal the joint between the log cabin and its base with silicone (not included). Anchor your log cabin to its base (e.g. with L-brackets, not included) to protect it from stormy weather.

C "Wood lives", a saying that also applies to your purchase. In concrete terms, this means that the height of the log cabin varies depending on the humidity. If you install vertical or horizontal structures (e.g. shelves, electrical wiring, storm braces, etc.), you must ensure that you do not impede this natural movement of the wood. If you connect the wood vertically in certain places, gaps will appear between your logs during periods of low humidity, often resulting in deformation of the log cabin. Do not be alarmed if you notice a gap above the door and window during the assembly of your log cabin. These are designed to accommodate shrinkage and expansion. We supply matching cover strips to conceal this gap.

D Remove the parts of your log cabin from the packaging two days before assembly. This will allow the wood to acclimatise to the humidity. Place the logs slightly apart, sheltered from rain and sun. Now carry out a full check using the enclosed parts list. Complaints about materials will not be accepted if the parts have been painted. Complaints must be submitted to us no later than 8 days after delivery.

E Wood is a natural product. This means that slight variations may occur. What are **acceptable** variations?

- Knots,
- Fallen knots no larger than a thumb,
- Fallen knots or slight damage to the edges (tongue and groove) if coverage is guaranteed during assembly,
- Discolouration in the wood,
- Straight cracks that do not split the log, splitting cracks that are no longer than 12 cm,
- Resin pockets of max. 5 cm,
- Wood that is slightly bowed, if assembly is still possible (the pressure of the roof will usually keep the log straight).

F Ensure that your log cabin is **anchored** to its base (e.g. L-brackets, not included). Also ensure that you have effective vertical storm bracing that takes into account the tips mentioned in point C "Wood lives". Gardenas dealers sell our special storm bracing products.

G Do not use nails or screws when assembling the walls. The pressure of the roof with the storm bracing will ensure that your log cabin remains standing.
To prevent splitting, we recommend that you pre-drill with a drill bit that has a smaller diameter than the diameter of the screw.

H If a part is damaged during assembly, or are you having trouble figuring it out?

Our after-sales service is at your disposal:

- during office hours by telephone: +32 (0)52 21 95 71
- by fax: +32 (0)52 22 09 03 or
- by e-mail info@gardenas.be
- If you notice any damage to the package, please let us know within 48 hours.

After checking the accompanying parts list, you can start assembling.
What do you need? A saw, a try-square, a piece of auxiliary wood, a screwdriver (preferably battery-powered or electric), 2 ladders, a rubber mallet, a drill, silicone. At least 2 adults are required for assembly. Keep children and pets away during assembly.

1.

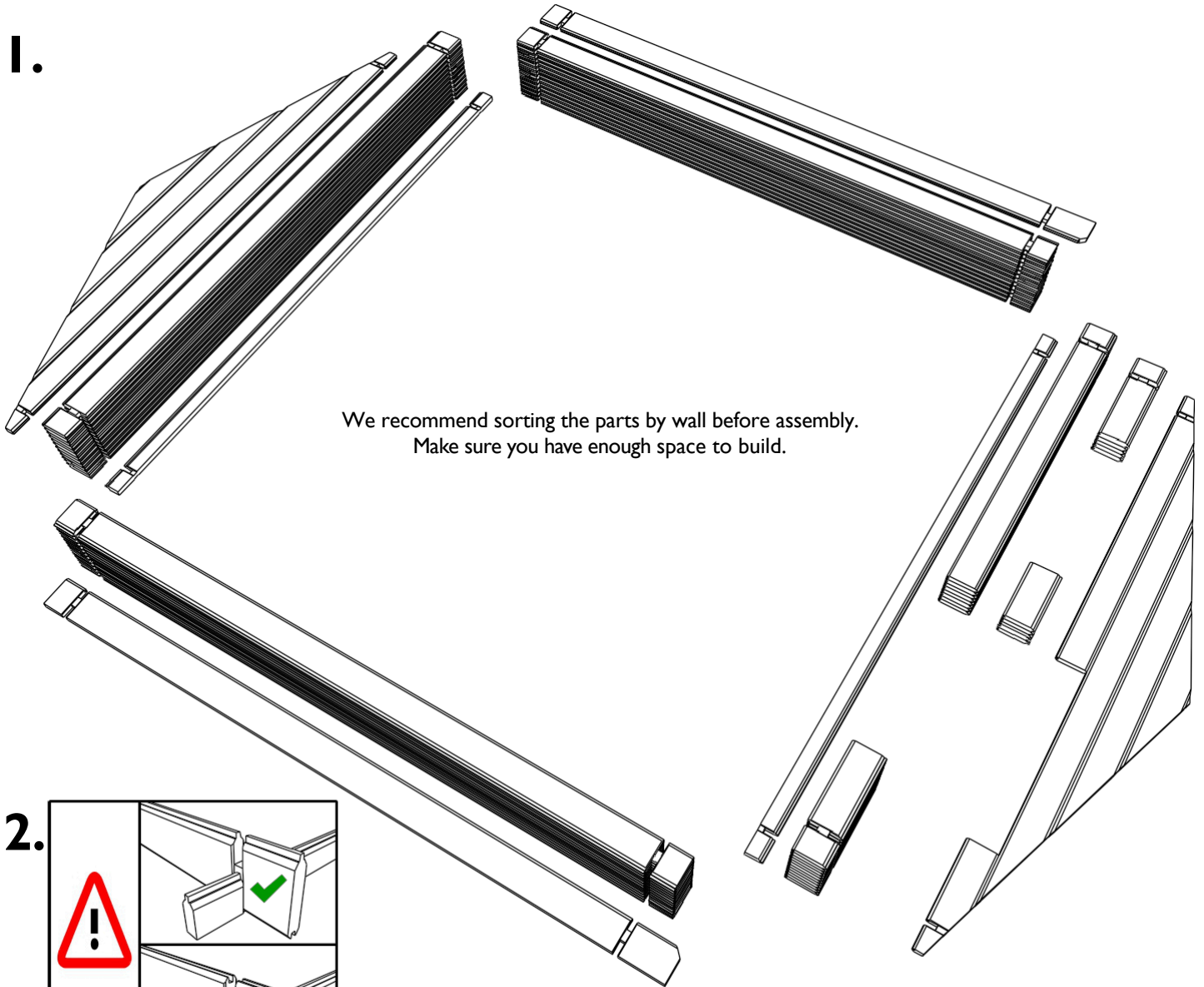

2.

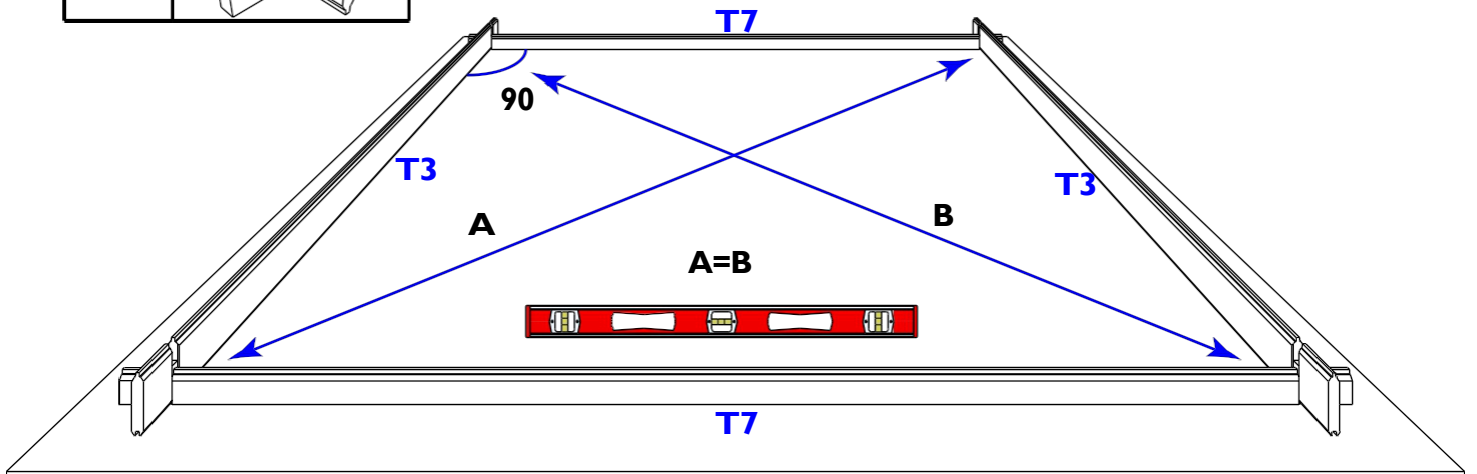
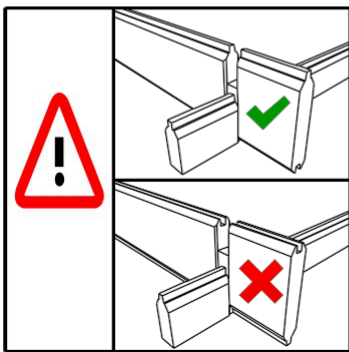

3.

Continue to assemble the log cabin as indicated on the wall drawings in the parts list up to 3 logs high. If the door of your model is not centred, you can choose on which side to place the door. Use a hammer to ensure the logs fit together tightly. However, never strike the wood directly (damage to the tongue can make assembly more difficult), but strike a piece of auxiliary wood or use a rubber mallet.

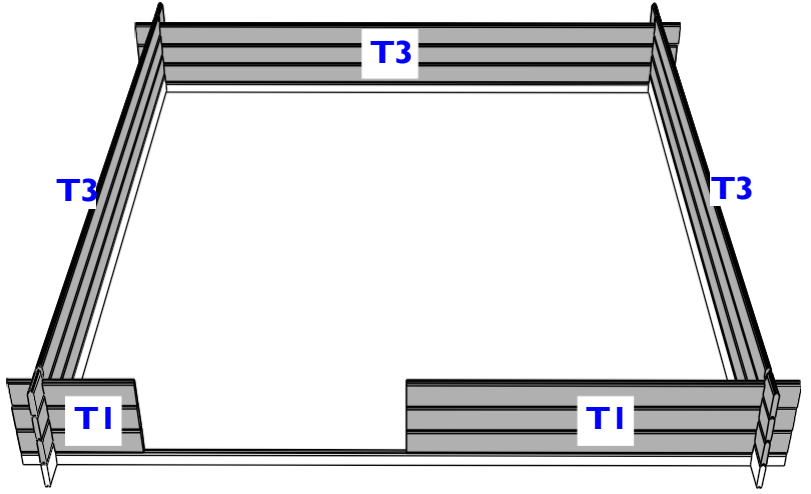

If a warped/crooked log does not fit:

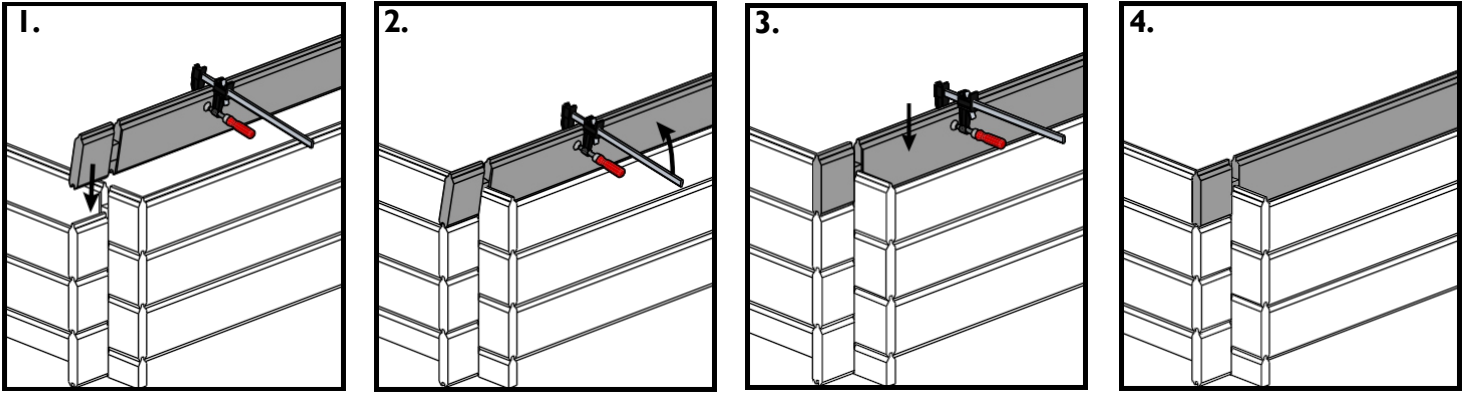

4. Lower the door jambs into the opening. **Secure the door jambs to the log cabin at the bottom only, using a screw on the inside of the garden shed. Never screw into the log cabin itself at the top** (see tips and advice on 'wood lives'). It is best to finish the door once the log cabin is fully assembled.

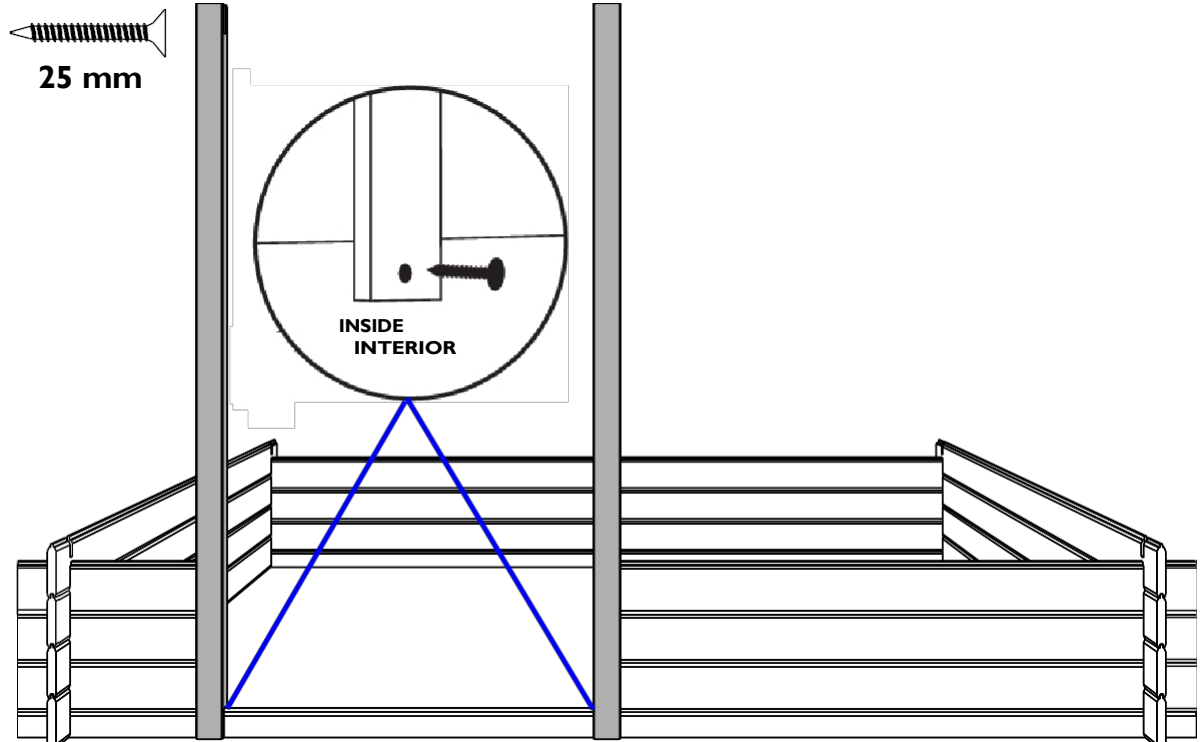

- 5.** Continue building according to the plans provided (see parts list) until you reach the height of the window, if your model has one. Do not attach your window frame to the logs of your log cabin with screws or nails (wood lives!). Continue building to the top.

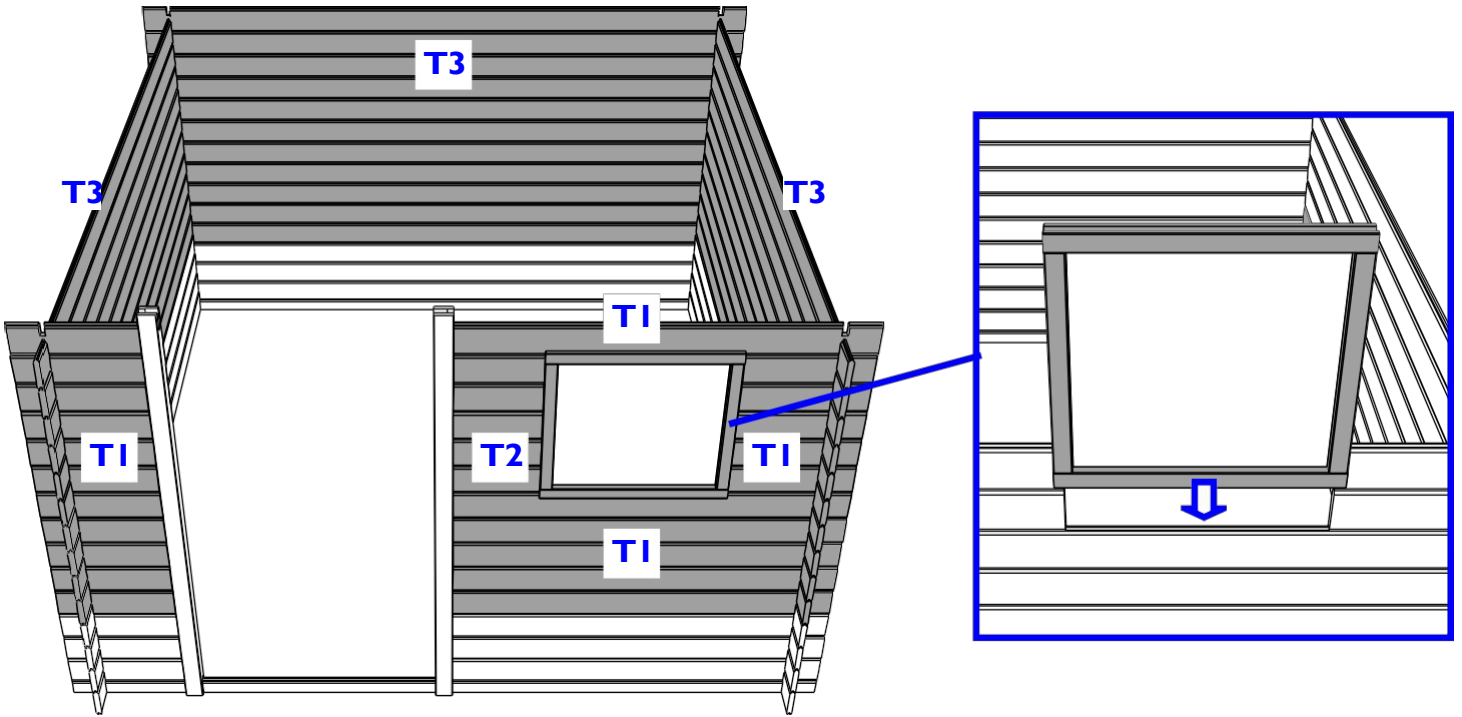

- 6.** Now mount the T5 logs with the flat side.

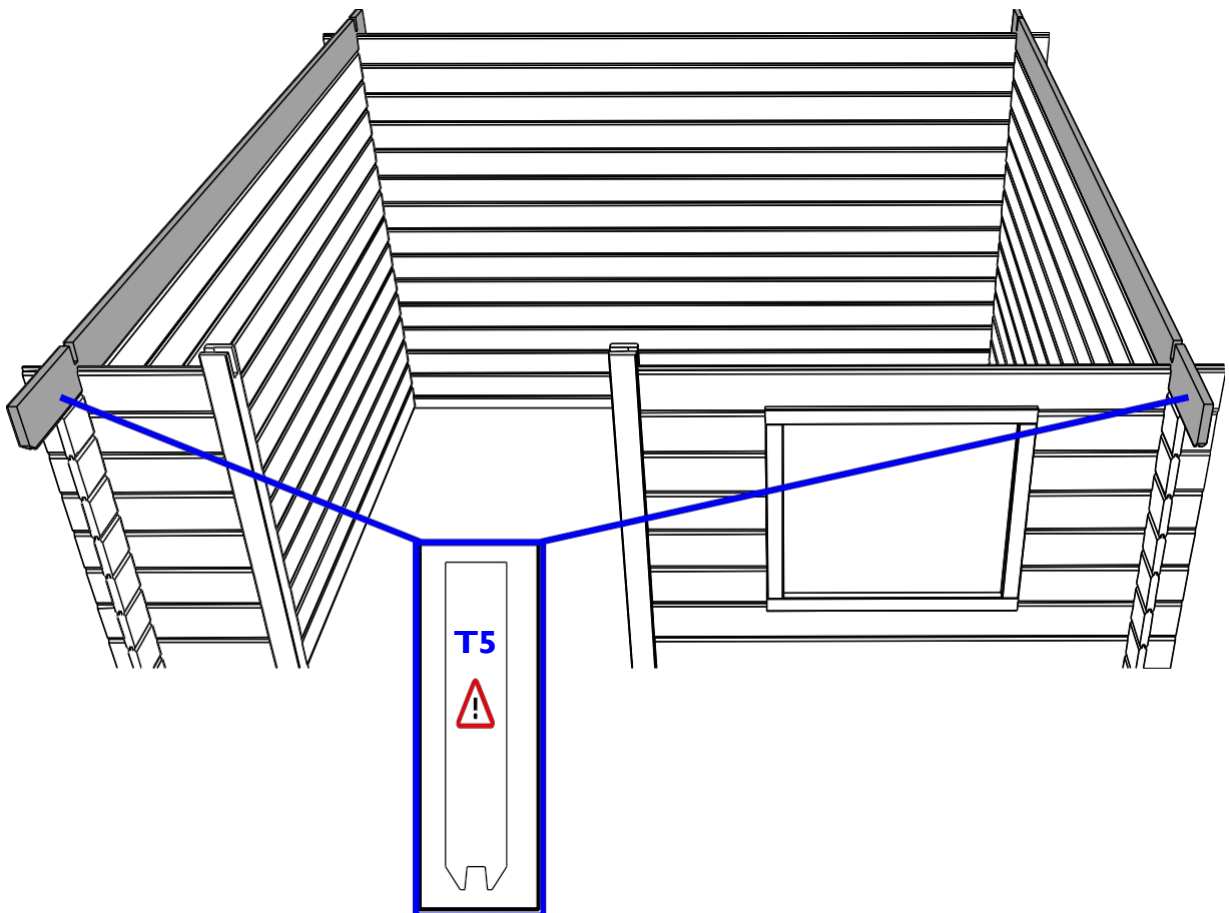

- 7.** Now assemble the gables TK/S4 and screw them in place. The notches for the roof rafters may vary depending on the model you have purchased (see plans in the parts list).

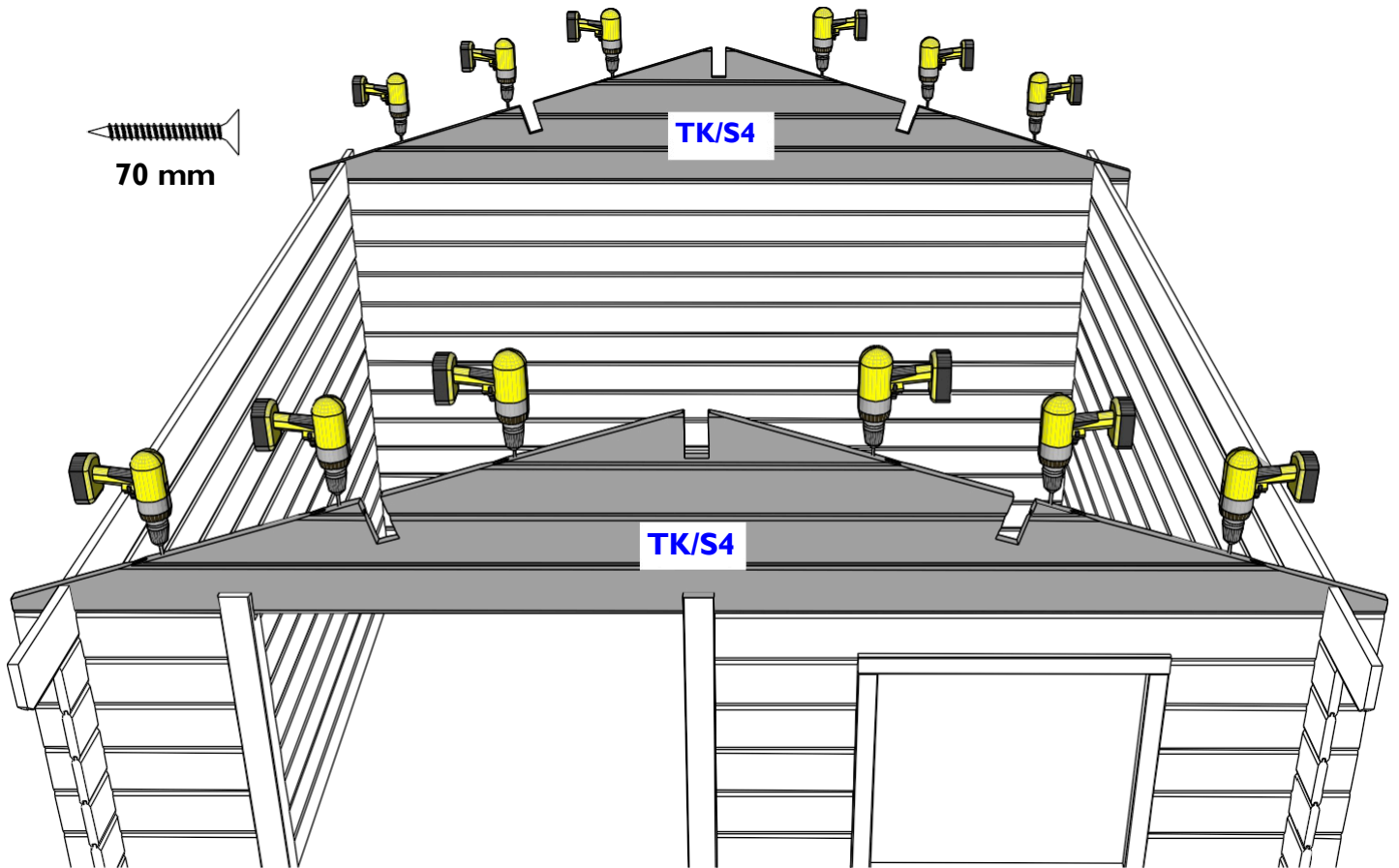

- 8.** Now mount roof rafters PI level with the most protruding log of the side wall and screw them in place. The roof rafters may vary depending on the model you have purchased (see plans in the parts list).

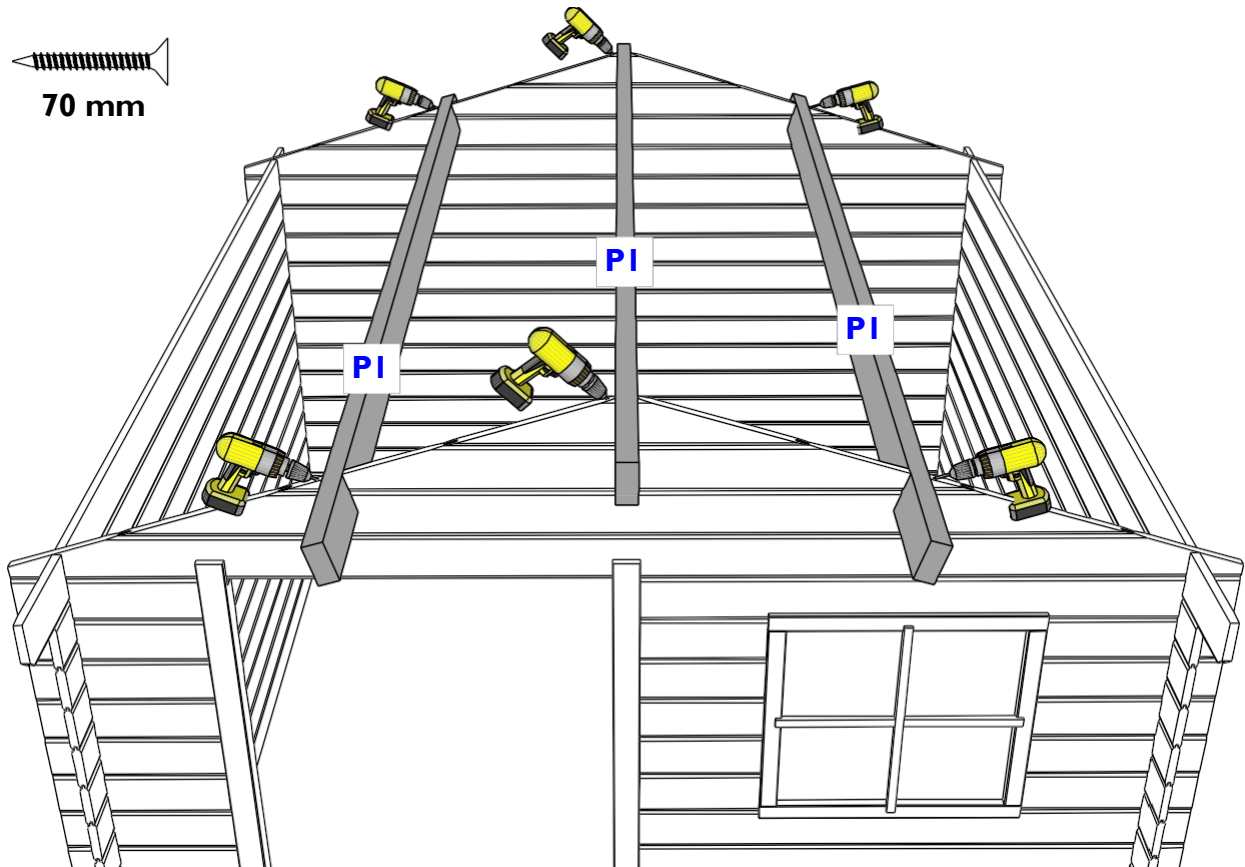

9. Place the first roof board at the front with the tongue facing you (the tongue should point towards the front of the log cabin). Ensure that the roof boards are positioned to cover half the width of the ridge beam and that the first roof board is set 5 mm back from the front of the roof rafters (these 5 mm serve as an expansion gap). Nail the roof boards twice onto every roof rafter and onto the side wall. Always nail as close as possible to the outer edge of the roof board without touching the groove or tongue, so that you can connect the next roof board. Now attach the second roof boards and continue working towards the rear, using the ridge beam as an alignment guide. Ensure that the distance that the roof board protrudes over the side at the front, in the middle and at the rear is the same.

ATTENTION! Do not fit the roof boards too tightly, so that there remains enough space for the logs to expand and contract ('wood lives'). Ensure that the tongue and groove of the roof boards are slotted together, but in such a way that the wood still has approximately 2 mm of space to move (you will still see 2 mm of the tongue).

Continue finishing the back of the log cabin. It is possible that the back will not fit perfectly against the rear of the roof rafters. Saw the last batten lengthwise, and do not forget to leave a 5 mm expansion gap. Now finish the other side of the roof in the same way.

50 mm

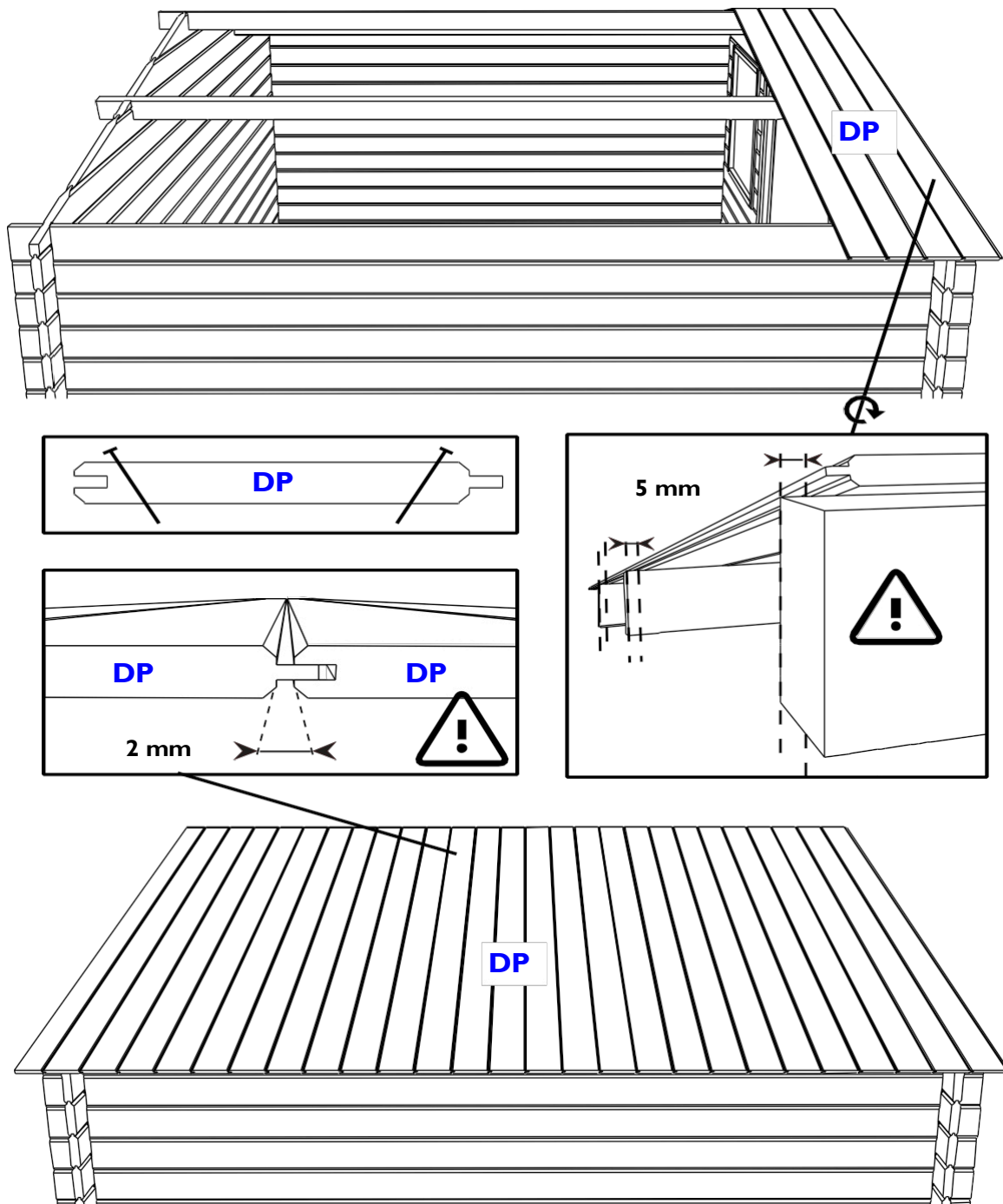

10. You will need to cut the rolls of roofing felt to size (see the parts list for the correct length). Only apply roofing at temperatures above 15°C. If necessary, you can store the roofing in a heated room until you need it. Secure the sheet with shingle nails every 10 to 15 cm at the top and bottom. Do not nail too deep, as this may cause water infiltration, but make sure it is flush with the roofing. In areas exposed to strong winds, you should secure the roofing extra firmly using cold roofing adhesive (not supplied). It is not recommended to torch the roofing, as the wooden roof structure is flammable. **To install the roofing sheets, start at the bottom (in the depth direction, towards the ridge line) and work your way up.** Let the bottom sheet overhang the roof boards by 10 cm and bend the roofing 5 cm over at the front and back. Apply the next strips, ensuring sufficient overlap with the previous one (you should distribute the sheets symmetrically across the roof slope). Again, make sure the roofing overhangs by 5 cm at the front and rear. The roofing sheets that cross over the ridge should overlap beyond the roof ridge. Depending on the model purchased, the number of sheets may differ from the drawings.

┌
14 mm

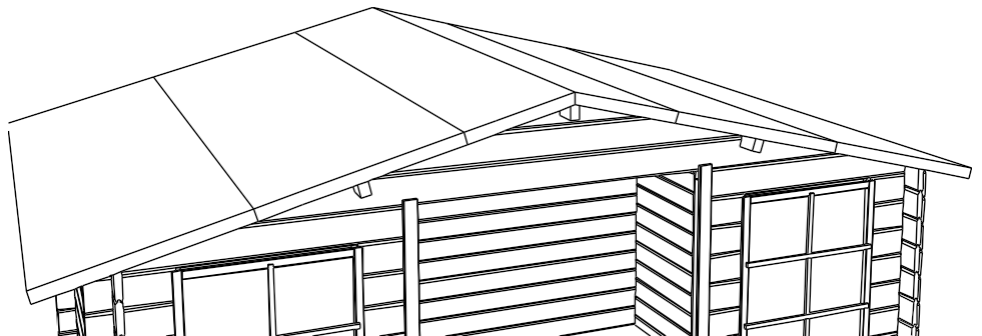
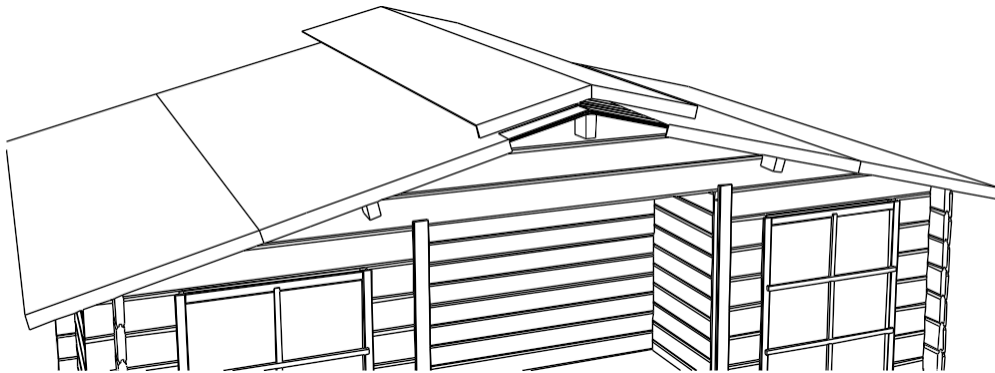
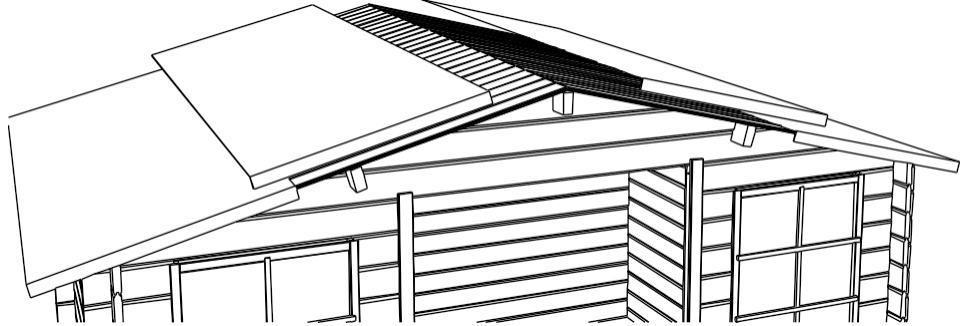
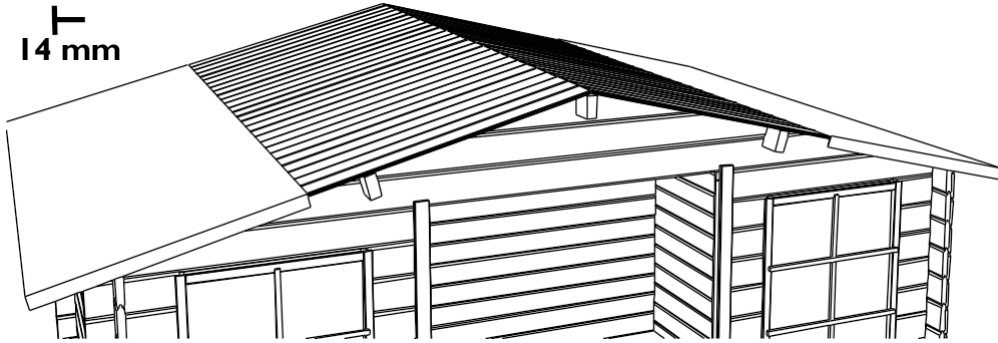

11.

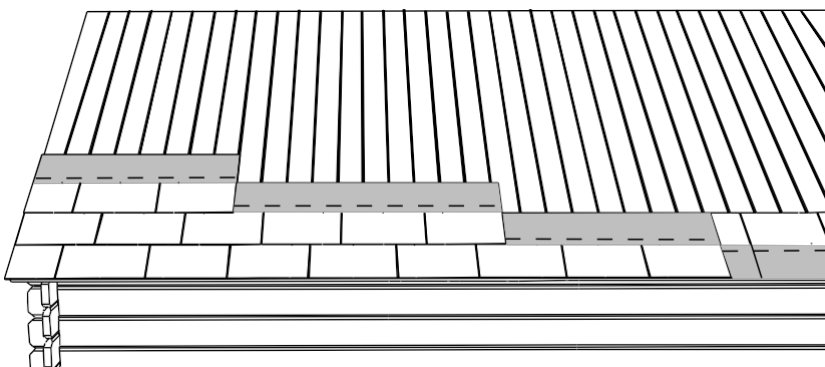
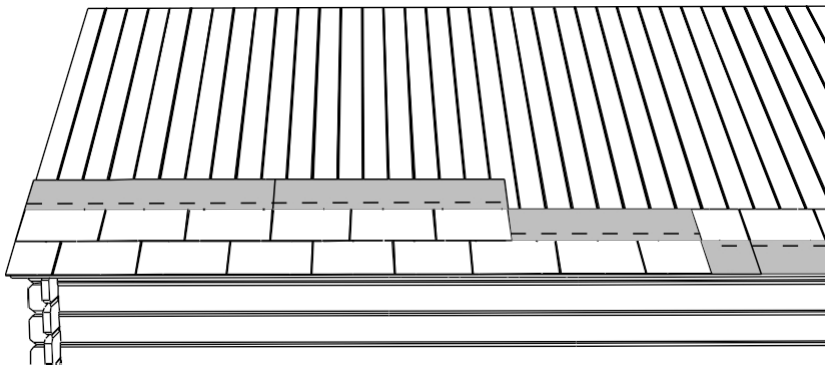
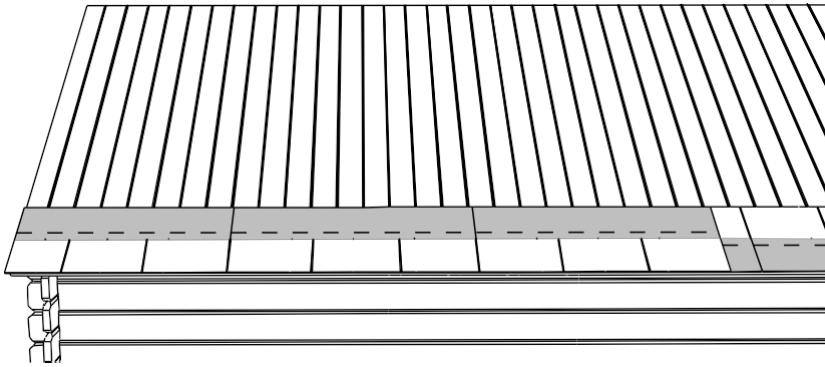
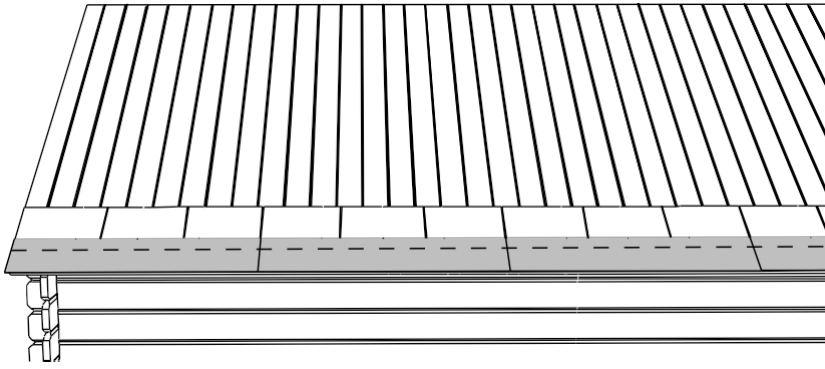

To cover the ridge, cut the shingles diagonally into pieces as shown in the drawings on the packaging. Then lay these pieces overlapping each other. Take the direction of the wind into account when determining the overlap direction. Nail them with two nails at the point where the next piece will overlap.

(only for optional shingles)

To install any optional shingles, start at the bottom and work your way up. Lay the first row of shingles with the cutouts facing upwards. Allow this first row to extend 3 cm beyond the edge of the roof. Nail only this row at the top and bottom, using 4 shingle nails per shingle. Lay the next layers with the cutouts facing downwards. Nail 4 nails into the top of each shingle. The second layer should completely cover the first, but make sure that the cutouts are staggered. For the third layer, stagger the cutouts again. Continue in this way until you reach the top of the ridge line. At the front and back of each row, cut the shingles flush with the roof boards. Use a utility knife for this. If this piece of waste is larger than 1 tab, you can use it to start the next layer. If you are installing the shingles in cold weather, you should glue them with cold adhesive. The shingles will only adhere properly in warm weather. (see packaging).

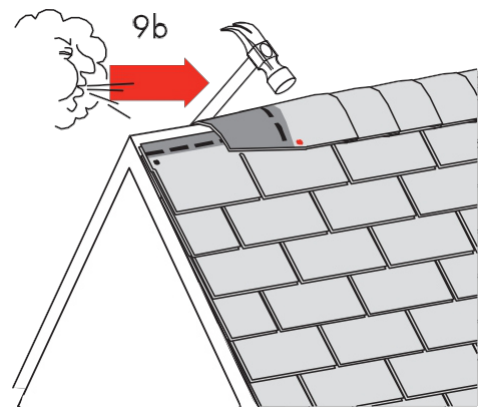
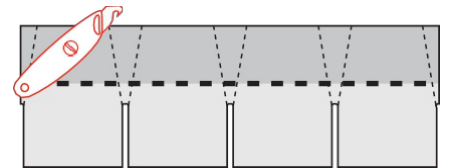

- 12.** On the side, the roofing is folded around the roof edge. At the bottom, nail the RL battens (several pieces per side) into the roof panel with 3 x 35 mm screws per batten. **Caution!** To prevent the roofing from tearing, do not stretch it tightly around the corner. Fold it 'loosely' around the corner with a curve.

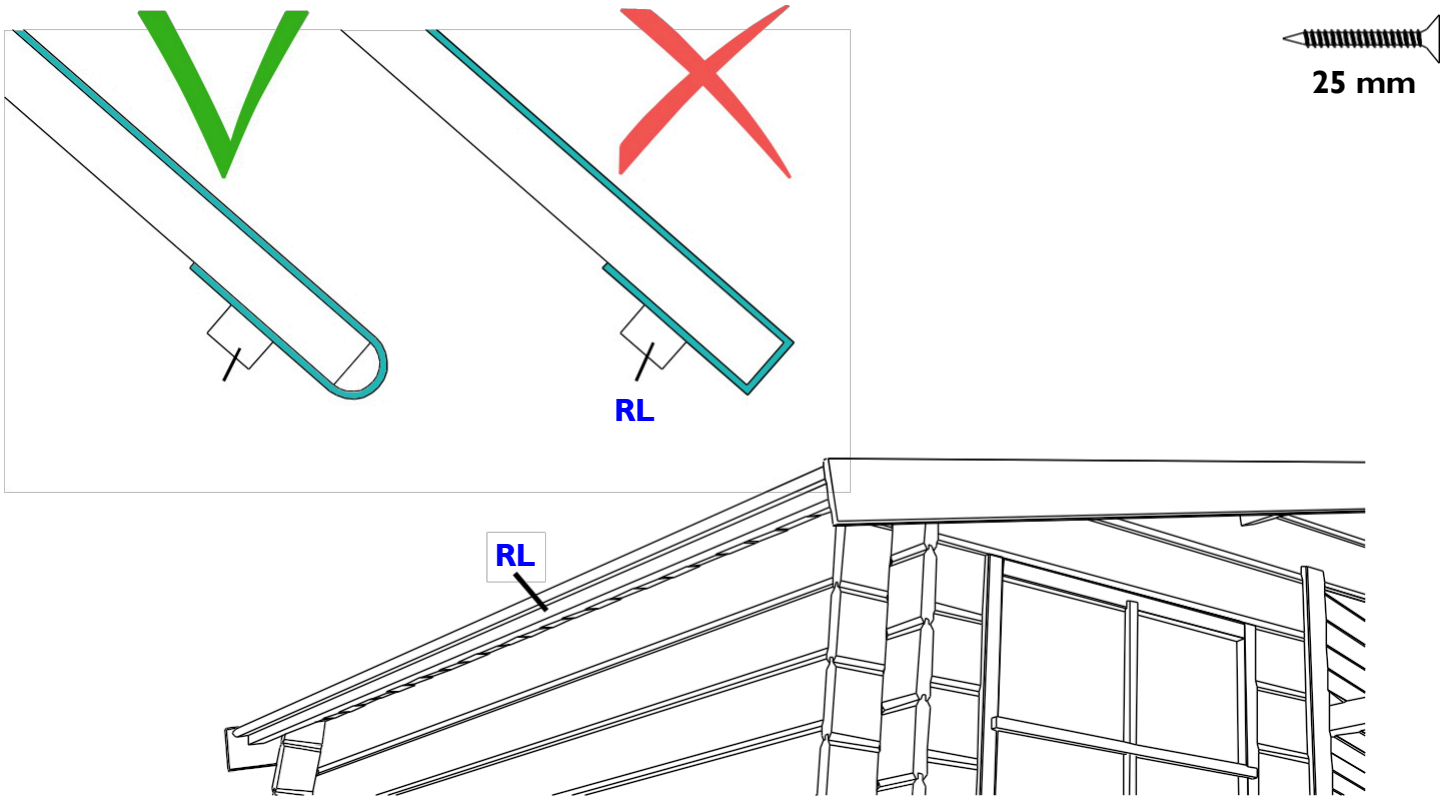

- 13.** Now install the trim battens FSL. Where the logs meet at the ridge, cut the trim battens at a miter joint. Screw them into each roof rafter and into log T5. Repeat this at the rear.

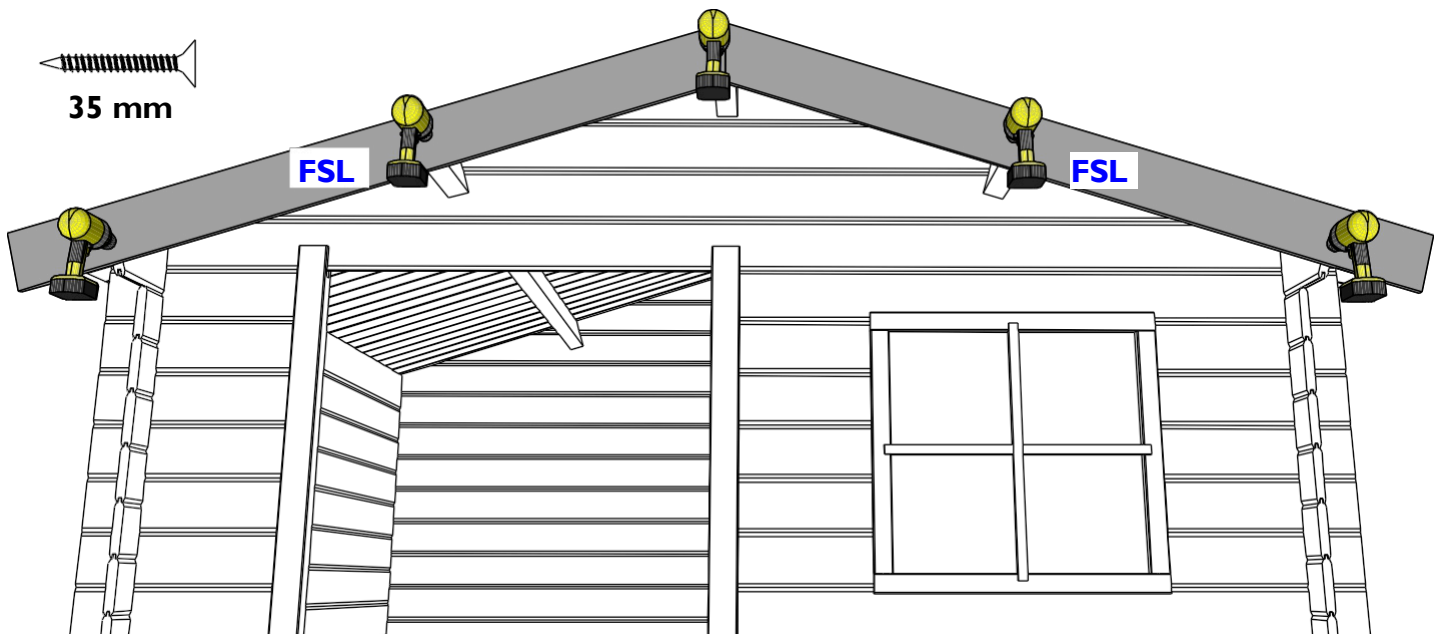

14. Fit the diamond finial S. Repeat this at the rear.

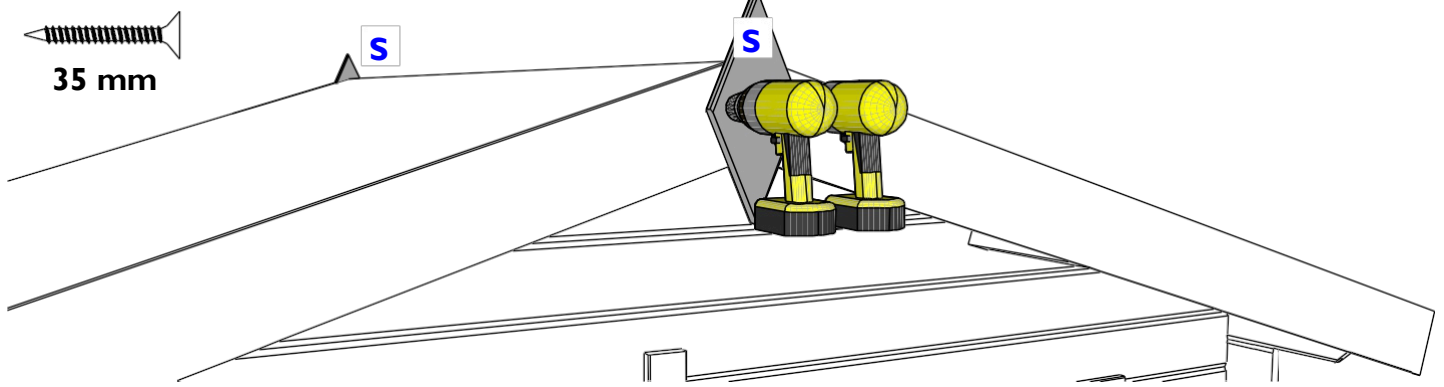

15. Fit the hinges. Hang the doors in the door opening, with the hinges on the outside of the door jamb. Check that the door leaves are hanging straight. Secure the door jambs at the top of the door frame (inside) by screwing a block (SSL45) to the left and right of the jamb. Never attach the door jamb directly to the log cabin ('wood lives'). Install the padlock hasp between the two parts.

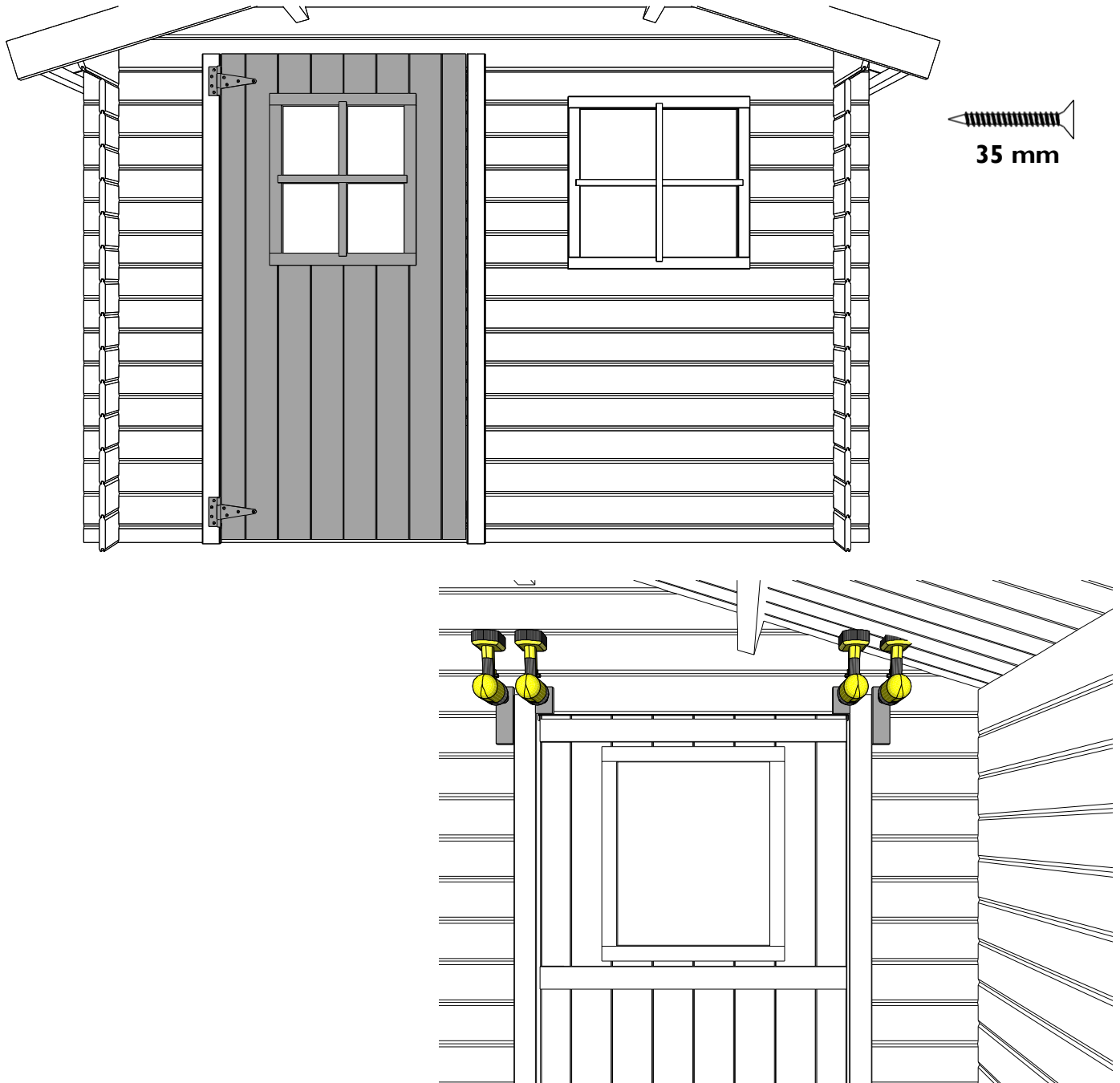

- 16.** Seal the following areas with silicone (not included):
- The joint between the log cabin and its base on the outside,
 - Around the glass.

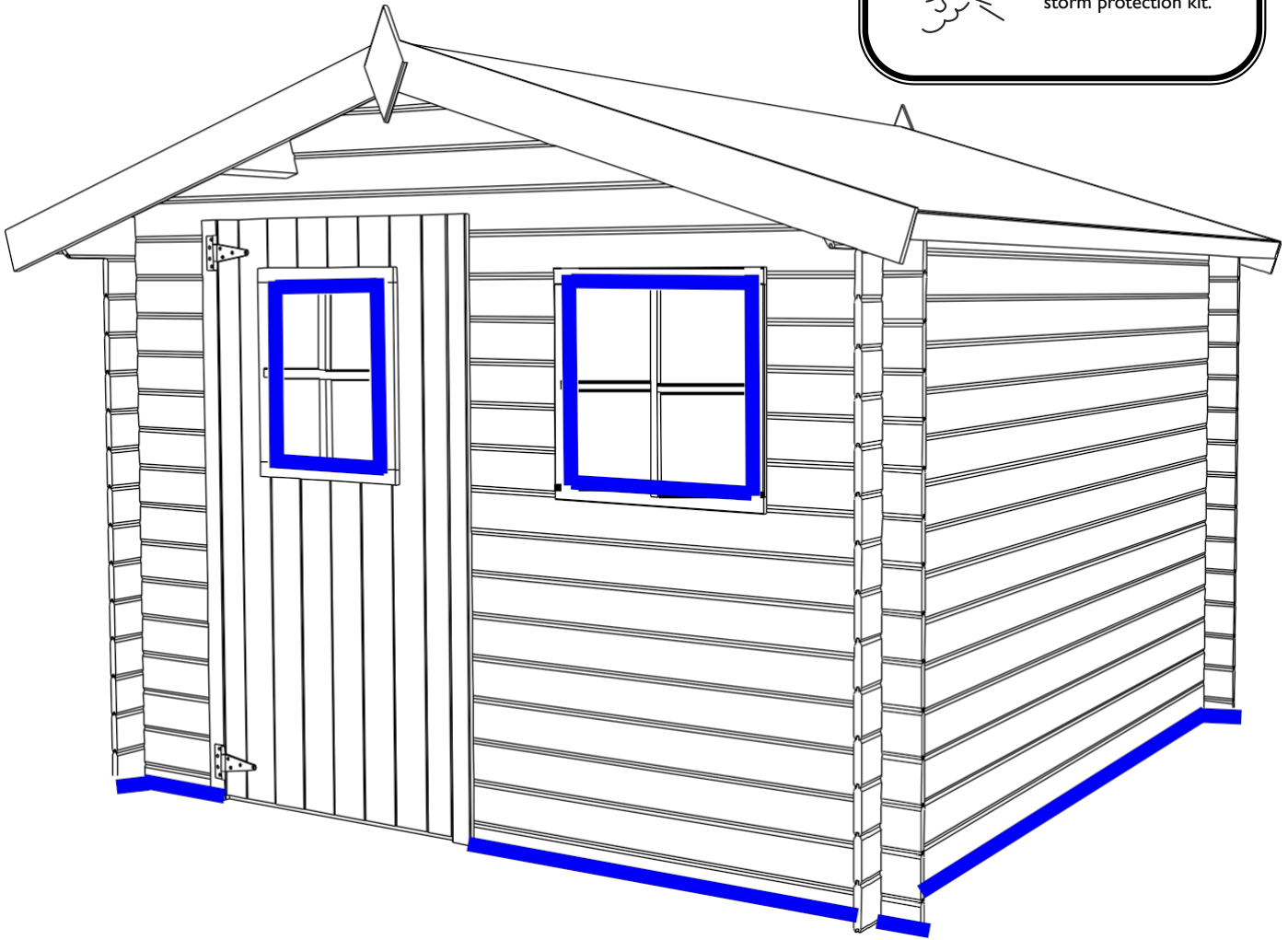

To make your log cabin storm-resistant, you will need to install storm bracing. This connects the roof and walls to the base. So make sure it is properly secured to the ground. Always ensure that you do not obstruct vertical shrinkage and expansion (see 'wood lives'). Gardenas dealers sell our standard storm bracing. An alternative is to attach a screw to both the top and bottom logs and stretch a nylon cord between them. In any case, you must ensure that the force of the storm bracing does not cause the wall to bulge. If this is the case, you must adjust the bracing.

Maintenance: water, wind, snow and sun are the main enemies of your log cabin. Ask a specialist for advice if you have any questions about products, timing, etc. for treatment.

Product liability applies only if the log cabin has been assembled in full compliance with these assembly instructions.

WARRANTY

The product is made of wood, a natural product that, due to its outdoor placement, will continue to "live" and therefore requires ongoing attention. Assembly, treatment and anchoring will be carried out by or on behalf of the customer. Gardenas is therefore responsible for and provides a warranty on the product and its components themselves, but not for the consequences of incorrect assembly, missing or inadequate anchoring, or incorrect or inadequate maintenance.

How long?

Unless otherwise stated, Gardenas offers a 5-year warranty on its products. Fittings and roofing are covered by a 2-year warranty. Products sold as pressure-impregnated are covered by an extended 10-year warranty against rot, mould and insect damage to the wooden parts.

The warranty period starts from the date of purchase.

What is covered by the warranty?

- The structural design of the product for safe and normal use.
- The correctness of the parts in terms of quantity and shape upon delivery. Any deviations must be reported no later than 14 days after delivery.
- The warranty is limited to the replacement of defective, damaged or unusable parts.

What is not covered by the warranty?

- Costs of (re)installation, production, assembly, treatment.
- Parts that are no longer in their original condition.
- Defective parts that were installed anyway.
- Minor deviations from the natural material, whether or not specified in the manual, which do not compromise the stability and expected lifespan of the product (e.g. knots, cracks, discolouration, slight deformations that can be assembled and will have no impact after assembly or will be invisible after assembly, etc.).
- Damage, deformations or defects resulting from ignoring to strictly follow the advice and instructions in the product manual and/or incorrect or careless use of the product, as well as damage caused by poor foundations.
- Damage and degradation and their consequences due to inadequate treatment of the product.
- Damage caused during transport and storage, whether or not due to extreme humidity, if transport and storage were not carried out under Gardenas' management.
- Damage caused by third parties, animals, insects (except if the product was delivered pressure-impregnated) and termites.
- Natural ageing or discolouration of the product.
- Damage caused by a roof load (e.g. snow) of more than 50 kg/m².
- Direct or indirect damage to items and materials stored in or under the product.
- Consequences of force majeure: storms, natural disasters, floods, vandalism, etc.

Parts availability and delivery

Gardenas guarantees the availability of all parts or a valid alternative for each part for up to 5 years after purchase of the product, regardless of whether the part is still under warranty or not.

Gardenas will make every effort to provide any replacement parts as quickly as reasonably possible. Gardenas will deliver the parts in the same manner and to the same location as it delivered the original product.